

Installation- and Operating Instructions

Side Channel Vacuum Pumps/Compressors

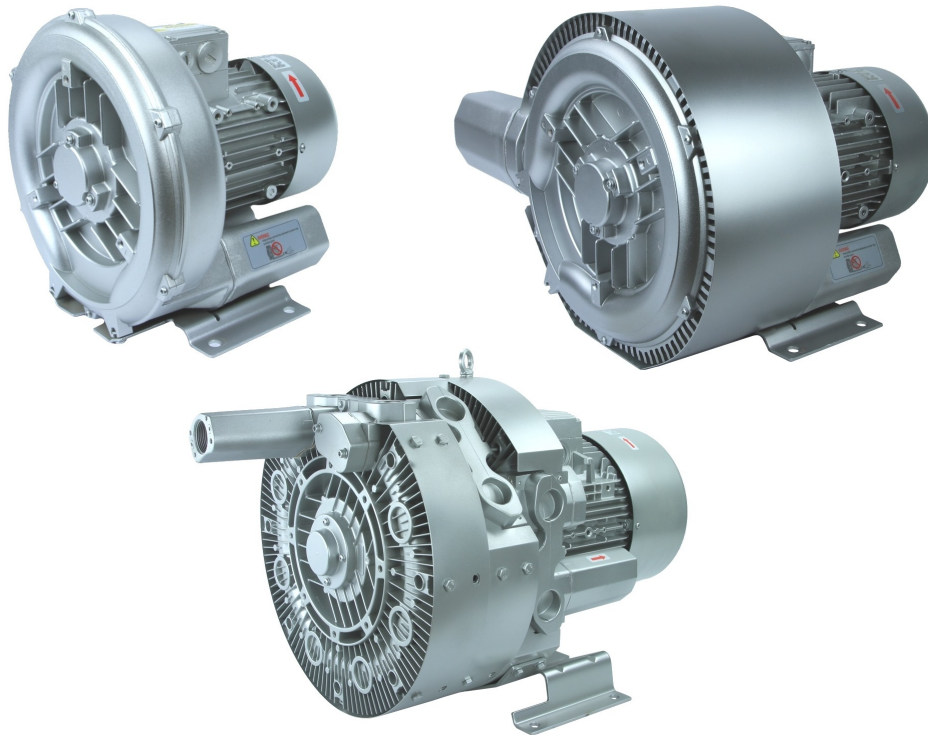

Series SKV-NS / SKV-ND / SKV-NDF
Series SKV-HS / SKV-HD / SKV-HT

High quality – Fair prices

SKV-tec GmbH
Forchheimer Str. 4
91338 Igensdorf
Germany
Tel.: +49 (0) 9192 – 99 53 14
Fax: +49 (0) 9192 – 99 52 68
www.skv-tec.de
info@skv-tec.de

Index

1	Important basic information.....	3
1.1	Definition.....	3
1.2	Safety instructions.....	3
2	Safety.....	4
2.1	Intended use.....	5
2.2	Potential misuse.....	5
2.3	General safety instructions.....	5
2.4	Residual risks.....	6
3	Design and function.....	7
3.1	Nameplate.....	7
3.2	Model type (Code).....	7
3.3	Description of the unit.....	7
3.4	Design and operating mode of the unit.....	7
4	Transport, storage and disposal.....	8
4.1	Transport.....	8
4.2	Storage.....	9
4.3	Preservation.....	9
4.4	Disposal.....	9
5	Installation and connection.....	10
5.1	Preparation.....	10
5.2	Set-up of the unit.....	10
5.3	Connecting pipes/flexible pipes.....	11
5.4	Electrical connection.....	12
6	Operation.....	14
6.1	Preparations prior to commissioning.....	14
6.2	Commissioning.....	14
6.3	Decommissioning.....	16
6.4	Recommissioning.....	16
7	Service and maintenance.....	17
7.1	Monitoring of the aggregate.....	17
7.2	Cleaning of contaminations.....	17
7.3	Replacing the deep groove ball bearings.....	18
7.4	Service / Support.....	18
7.5	Spare parts.....	18
7.6	Disassembly of the unit.....	18
7.7	Assembling of the unit.....	19
8	Troubleshooting.....	20
9	Technical Specifications.....	22
9.1	Operating conditions.....	22
9.2	General technical data.....	22
10	Indications according to ecodesign regulation (EU) 2019/1781.....	22
11	Appendix.....	23

1 Important basic information

These operating instructions contains information about

- product description,
- safety,
- transport,
- storage,
- set-up and operation,
- maintenance,
- servicing,
- troubleshooting and
- spare parts

of the side channel blower.

"Handling" of the side channel blower in terms of these operating instructions are the transport, storage, set-up, operation, control over operating condition, maintenance, troubleshooting and servicing of the side channel blower.

Prior to handling of the side channel blower the responsible staff for operation and servicing have to completely read and understand the operating instructions. The operating instructions have to be strictly adhered to. The operating instructions and all enclosed documents have to be kept at the place of installation, always available to personnel.

If there are doubts, please contact the responsible representation of the SKV-tec GmbH!

1.1 Definition

aggregate	complete side channel blower including pump, power unit and its components
pump	side channel blower without power unit and components
safety valve	valve for limiting the generated vacuum resp. pressure

1.2 Safety instructions

The side channel blower have been designed and manufactured in accordance with state-of-the-art technology. Nevertheless by exposure of the side channel blower there will remain some threats. In these operating instructions we will refer at suitable points to threats.

Safety instructions are marked with keywords like **DANGER**, **WARNING**, **CAUTION** or **ATTENTION**:

	⚠ DANGER
	<p>Risk of personal injuries!</p> <p>Disregarding this safety instruction leads to accidents resulting in death or severe injuries.</p>



	⚠ WARNING
	<p>Risk of personal injuries!</p> <p>Disregarding this safety instruction can lead to accidents resulting in death or severe injuries.</p>



	⚠ CAUTION
	<p>Risk of personal injuries or property damage!</p> <p>Disregarding this safety instruction can lead to accidents with minor injuries or property damage.</p>



	ATTENTION
	<p>Risk of hearing loss!</p> <p>Depending on the size, the unit can emit sound of high volume. Depending on the operating state of the unit can emit sounds in a narrow frequency band.</p> <p>During longer stays in the vicinity of a non-sound-insulated aggregate hearing protection should be worn.</p>



2 Safety

The manufacturer is not liable for damages caused by non-observance of these operating instructions.

	 WARNING
	<p>Risk of death or serious injuries due to improper use of the unit!</p> <p>→ These operating instructions have to be fully read and understood prior to any work on the unit. The operating instructions have to be strictly adhered to. The operating instructions and all enclosed documents have to be kept at the place of installation, always available to personnel!</p> <p>→ Operation of the unit is only permitted for the purpose indicated under "Intended Use". It has to be operated at the values indicated under "Technical data"!</p> <p>→ Handling and all work on and with the unit have to be carried out by qualified personnel!</p>

	 WARNING
	<p>Risk due to pressure and vacuum! Risk caused by escaping media!</p> <p>Before starting work on the unit:</p> <ul style="list-style-type: none"> • At the connections suction and discharge nozzles conduits were installed • These connections may not be blocked, polluted or closed • all conduits are tight and have a sufficient strength <p>→ When working on the unit, protective equipment has to be worn! → All the connections are tested at regular intervals for strength and tightness!</p> <p>Risk of injury by the operation of the unit!</p> <p>When operating the unit the unit must not be touched nor works are carried out on this!</p>

	 WARNING
	<p>Risk of injury due to working on the unit by cutting, crushing! Danger of burns and scalding by contact with hot surfaces or media!</p> <p>→ When handling the unit suitable protective equipment (safety helmet, shoes and gloves) is to be worn!</p> <p>Risk of injury by pulling in and/or unwrapping of hairs/clothes by moving and rotating parts!</p> <p>No loose hair and / or wide, loose clothes! → Wear suitable personal protective equipment e.g. hairnet!</p>
	<p>Danger from rotating parts!</p> <p>Before operating the unit, it has to be completely assembled. In particular check the blower cover, the silencers on the nozzles and the fan cow!</p> <p>Because the impeller is accessible through the suction / discharge connections, the following are prohibited:</p> <ul style="list-style-type: none"> • Reaching into the unit through open connections • Insertion of objects into connections of the unit

	 DANGER
	<p>Electrical danger!</p> <p>Any electrical work has to be performed by a qualified electrician!</p> <p>Before starting work on the unit the following provisions have to be performed:</p> <ul style="list-style-type: none"> • Disconnect the unit from the mains • Ensure the absence of voltage • Secure against restart • Earth and short circuit • Cover and safeguard neighboring live parts

2.1 Intended use

- All provisions of this manual, including all safety instructions have to be observed
- Inspection and maintenance intervals have to be complied with
- The unit have to be operated exclusively for the delivery of approved media. It is used for compressing, conveying and suction of following approved media:
 - dry air/gases, which are neither explosive, inflammable, aggressive or toxic
 - Air or air-steam mixtures containing no solids. If there are small amounts of fine dust a corresponding filter has to be provided.
- i The rolling bearings used are sealed on both sides only with shields. Therefore they have to be changed regularly as instructed in Chapter 7.3!
 - For media with a density greater than air (higher thermal and mechanical loading on the machine) **the responsible representation of the SKV-tec GmbH has to be contacted!**
- The unit is for continuous operation. For this purpose, it has to be ensured that waste heat can be delivered freely to the environment and that a certain minimum gas flow rate is guaranteed. Furthermore, frequent switching operations cause an increase of the temperature of the winding. **In case of more than 5 start-ups of the side channel blower in an hour (when spread across the hour, even less when the switching operations happen in a short time), the responsible representation of the SKV-tec GmbH has to be consulted!**
- The following scenarios have to be avoided:
 - Overheating: The unit must not be operated above the maximum permissible differential pressure (see nameplate)! If this danger exists, a vacuum or pressure relief valve has to be provided.
 - Motor damage:
The following parameters have to be observed: the switching frequency of the unit, permissible fluid and ambient temperatures (nominal values: Fluid temperature = 15°C, ambient temperature = 25°C)
- i The motor protection switch has to be set at the nominal current as given on the nameplate. By not respecting the permissible operating temperatures, the temperature limit of the lubricating grease of the rolling bearings may be exceeded.
 - The unit is intended exclusively for professional use
 - The handling of the unit is only permitted by qualified personnel

**Prior to handling of the side channel blower the responsible staff for operation and servicing have to completely read and understand the operating instructions.
If in doubt, please contact the responsible representation of the SKV-tec GmbH!**

2.2 Potential misuse

- The operating limits of the unit concerning pressure, temperature of the medium, density, viscosity and velocity have to be observed and complied with
- The permissible density of the conveying medium has to be respected, otherwise the unit will be overloaded.
- i The power consumption of the motor increases with the density of the conveying medium.
 - Avoid sudden changes in the pressure of the transported gas
 - Sudden changes in the temperature of the transported gas have also to be avoided
 - Unauthorized opening of the unit will void any claims for defects
 - If the unit is not approved for the requested use, operation is prohibited in the following scenarios
 - Operation in rooms where explosive gases may be present
 - Extracting, delivering or compressing of explosive, inflammable, aggressive or toxic media

2.3 General safety instructions



The unit is designed and manufactured according to the state-of-the-art of technology and the generally acknowledged rules of safety. Nevertheless through exposure to the unit, danger to the well-being or even the life of the user or third parties as well as damage to the unit may occur.

Therefore, the following guidelines have to be observed:

- The unit may only be operated in a technically flawless condition and in compliance with the regulations, safety precautions and warnings included in this manual.
- Ensure that this manual and related documents are complete and readable. In addition, make sure that the staff has access to these documents at any time.
- Refrain from any operating mode which brings the staff or third parties at risk
- In case of error which impacts on safety, immediately shut down the unit and consult the person responsible for fault diagnosis.

2.4 Residual risks

 WARNING	
	<p>Risk of injuries from flying parts , which reach into the openings of the engine cooling or the coupling guard!</p> <p>→ Don't bring in lose parts!</p>
	<p>Danger of burns and scalding by contact with hot surfaces or media!</p> <p>→ Do not touch or wear safety gloves!</p>

 WARNING	
	<p>Risk of serious hearing damage due to noise emissions because of missing/defective silencers!</p> <p>→ Installation/Exchange of the relevant silencer</p>
	<p>Risk of hearing damage!</p> <p>Depending on the size, the side channel blower is emitting noise of high volume. Depending on the operating state the side channel blower may emit noise in a narrow frequency band.</p> <p>→ For longer stays near a not noise insulated side channel blower, ear protection should be worn</p>

3 Design and function

3.1 Nameplate

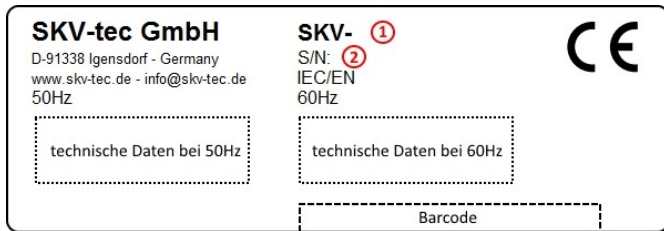

Figure 1: Nameplate

- 1 Product name
- 2 Serial number

3.2 Model type (Code)

	SKV	-	NS	-	50	-	3	-	906
Pump type									
Model design									
Model size									
Number of phase									
Engine code									

Figure 2: Model-/pump type

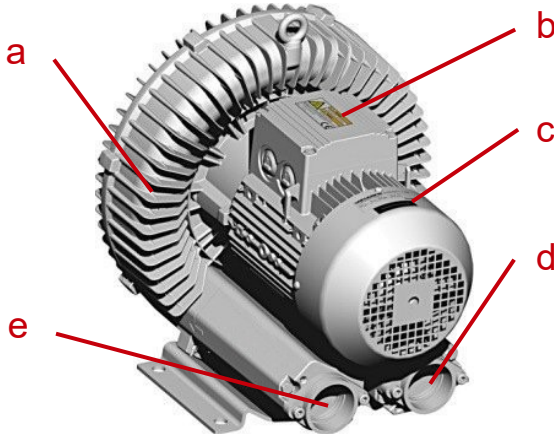

Figure 3: parts of the aggregate

Pos	Description
a	Direction arrow
b	Terminal box
c	Nameplate
d	Pressure side (gas outlet)
e	Suction side (gas inlet)

Table 1: Legend 3

3.3 Description of the unit

The aggregates are side channel blower for sucking or compressing air. They exist in the following designs:

- side channel blowers with one impeller (single-stage)
- side channel blowers with two impellers which differ in (double-stage)
 - double-stage design (higher pressure differential)
 - double-flow design (higher flow rate)
- side channel blowers with three impellers (triple-stage) (very high pressure)

Depending on the design the alignment of the suction/ discharge connections may vary. Details are shown in the data sheets of the respective aggregate.

The electric motor is modularly connected to the pump unit. The sealing of the driving shaft is ensured by a maintenance-free mechanical shaft seal.

3.4 Design and operating mode of the unit

The side channel blower operates according to the principle of pulse. Kinetic energy is transferred by the rotating impeller to the medium to be conveyed. This energy is converted into pressure. The side channel is formed by the specially shaped housing and the impeller, which is mounted directly on the motor shaft.

Via the suction connection, the gas is sucked in and accelerated at the side channel inlet by the rotating impeller in direction of rotation. By the centrifugal force, the gas is accelerated radially outwardly deflected by the wall of the side channel and supplied to the wheel again. With each repetitive feed into the impeller, the kinetic energy of the gas and hence the pressure increases. Through the cross-sectional constriction at the side channel outlet (breaker), the gas is ejected from the impeller and leaves the unit through the pressure connection.

The side channel blower can be used both for generating a negative pressure (vacuum) as well as for the generation of positive pressure.

The generated maximum differential pressure of the side channel blower depends on the power of the associated engine.

The side channel blower compresses the sucked gas absolutely oil-free, lubrication of the pump chamber is neither necessary nor permitted.



The side channel blower is cooled by



- Heat radiation from the surface of the side channel blower
- the air flow from the external fan of the motor
- the conveyed gas

4 Transport, storage and disposal

4.1 Transport

 The weight data of the unit has to be observed!

 	⚠ WARNING
	<p>Danger from overturning or falling loads!</p> <p>→ Before transporting all components have to be securely mounted. Loose parts have to be secured accordingly or removed!</p>

  	⚠ CAUTION
	<p>Overturning or falling loads can lead to bruising, fractures, etc.! Cuts from sharp edges!</p> <p>→ Protective equipment has to be worn !</p>



Packaging and inspection:

On delivery, the unit is screwed to a pallet and protected by a foil and a cardboard box. Unpack the unit and check for transport damage. Transport damages immediately report to the responsible representation of the SKV-tec GmbH!

Manual transport by hand:

	⚠ WARNING
	<p>Danger from lifting heavy loads!</p> <p>→ The permissible weights for lifting and carrying of components have to be observed!</p> <ul style="list-style-type: none"> • for men max. 30 kg • for women max. 10 kg • for pregnant max. 5 kg

Transport with lifting gear:

 	⚠ WARNING
	<p>Danger from overturning or falling loads!</p> <p>→ The following basic rules have to be observed when transporting with lifting equipment:</p> <ul style="list-style-type: none"> • the carrying capacity of the lifting gear has to be at least the weight of the aggregate • check the ring lug before each transport for a tight fit • The unit has to be secured against overturning/falling down • Do not stand under suspended loads

Depending on the model the transport has to be carried out in different ways:

- the following aggregates up to 30 kg can be transported by hand:
 - SKV-NS-50 up to SKV-NS-210
 - SKV-ND-88 up to SKV-ND-150
 - SKV-HS-47 up to SKV-HS-120
- all units over 30 kg have to be transported with a suitable lifting gear by means of a ring lug and/or straps. These are the following:
 - SKV-NS-280 to SKV-NS-1370
 - SKV-ND-230 to SKV-ND-1110
 - all SKV-NDF
 - SKV-HS-165, all SKV-HD and -HT

This list serves as a general guide line, prior to installation the operator has to be informed about the weight of the unit. The weights of the side channel blowers of the normal pressure and high pressure series can be found in the data sheets of the respective series.

If the unit is delivered on a pallet, it can be transported including its package with a hand lift truck / forklift truck.

4.2 Storage

The units are preserved ex works. This protects the aggregate for a maximum of three months when properly stored indoors. The following points have to be observed:

- Seal all openings and connections with appropriate sealing plugs or screw caps
- The storage room has to be dry, frost-free, vibration-free and protected. The ambient air must have a constant temperature with at most +40°C as well as a constant humidity.

For longer storage periods, poor storage conditions (e.g. aggressive atmosphere, frequent temperature changes, high humidity, etc.) or for aggregates which were already in operation and are going to be stored, the unit has to be resealed (see chapter 4.3, "Preservation").

	CAUTION
	<p>Risk of material damage due to improper storage!</p> <p>The unit have to be stored in accordance with the guidelines of this manual!</p>

Depending on the storage conditions, sealed rolling bearings need to be replaced when recommissioning the aggregate:

- Under favorable storage conditions: after 4 years
- Under unfavorable storage conditions (deviating from the specified storage conditions): after 2 years

4.3 Preservation

	CAUTION
	<p>Risk of material damage due to improper storage!</p> <p>The unit have to be handled in accordance with the guidelines of these operating instructions inside and outside with an approved preservative!</p>
	<p>Risk of corrosion due to condensate!</p> <p>Closures periodically removed so that accumulated water can escape.</p>
	<p>Risk of bearing damage!</p> <p>Mechanical shocks at standstill and in operation are to be avoided.</p>

- Seal all openings and connections with appropriate sealing plugs or screw caps
- Pack the unit in VCI film

i VCI stands for "Volatile Corrosion Inhibitor" (volatile corrosion inhibitor). VCI products (foil, paper, cardboard, foam) evaporate a substance that manifests in molecular thickness on the packaged goods and effectively suppress corrosion on many metal surfaces by their electrochemical properties. However, VCI products can attack plastics and elastomers. Seek advice from your local packaging dealer! SKV-tec GmbH uses CORTEC VCI 126 R film for the overseas packaging of larger aggregates.



- The storage room have to be dry, frost-free, vibration-free, protected and have to ensure a constant humidity
- The motor shaft have to be moved once a month. It have to be ensured that the position of the motor shaft and the ball bearings changes.
- Closures periodically removed so that accumulated water can escape
- For storage periods longer than 6 months all components made of elastomers (EPDM) have to be replaced for recommissioning. Components such as O-rings and shaft seals have to be checked for elasticity and replaced if necessary.

4.4 Disposal

	WARNING
	<p>Risks of environmental damage caused by liquid being pumped!</p> <ul style="list-style-type: none"> • Plastic parts have to be removed and disposed of separately • Residues of any kind in the aggregate have to be removed <p>→ Assign an authorized company with the disposal of the unit</p>

5 Installation and connection

	CAUTION
	<p>Risk of material damage due to contamination!</p> <ul style="list-style-type: none"> → Remove transport locks only immediately prior to installation of the unit → Remove the transport covers of the connections just before the installation of the pipes to the unit <p>Risk of material damage due to overheating of the unit!</p> <ul style="list-style-type: none"> → Set up the unit according to the specified minimum distances (see chapter 9.2, minimum distance WT) so that heat dissipation and cooling air are unimpeded! → Sucking air from other units has to be avoided!

     	WARNING
	<p>Overturning or falling loads can lead to bruising, fractures, etc.! Cuts from sharp edges!</p> <ul style="list-style-type: none"> → While transporting and installing protective equipment (safety gloves and safety shoes) has to be worn! → The unit has to be mounted on a solid foundation or a fixed acreage. The strength of the fittings have to be checked regularly! <p>Danger of tripping and falling !</p> <ul style="list-style-type: none"> → The unit must not form a tripping hazard! <p>Danger from flying parts !</p> <ul style="list-style-type: none"> → Ensure that loose parts are secured and/or removed! → Provide sufficient safety margin, so that no persons may be hurt by debris due to a fault in the external fan! <p>Risk of burns by hot surfaces and/or hot media!</p> <p>During operation the unit must not be touched because it may result in temperatures above 70°C at the surface! The installation of the unit has to be executed in such a way (e.g. perforated plate/wire cover) that accidental contact is prevented! Allow to cool after decommissioning!</p>

	DANGER
	<p>Electrical danger!</p> <ul style="list-style-type: none"> • Installation of the unit has to be performed in such a way that it does not harm the electrical device • Supply lines should be routed safely as cable ducts or in the ground <p>→ Any electrical work has to be performed by a qualified electrician!</p>

5.1 Preparation

→ The required environmental conditions (see chapter 9.1, operating conditions) has to be checked

→ Minimum distances (see chapter 9.2, minimum distance WT) for heat dissipation has to be observed

→ The location of the installation must meet the following conditions:

- The environment of the unit must not be at risk of explosion
- The unit has to be freely accessible from all sides
- The ambient conditions must comply with the degree of protection (e.g. IP55) of the drive motor (according to nameplate)
- The unit has to be set up vibration-free



Only with adequate vibration freedom faultless operation and a long service life of the equipment is ensured

5.2 Set-up of the unit

The guidelines from chapter 5.1, „Preparation“ have to be observed.

Furthermore, the following have to be observed when setting up the unit :

- has to be carried out on flat surfaces
- The unit can be installed in both horizontal and vertical axis position. If installed in vertical axis position, the side channel has to be facing down and the drive motor up to avoid a heat accumulation.
- on stationary surfaces or structures, it has to be ensured that this surface is designed for at least the weight of the aggregate
- the unit has to be secured with the appropriate feet/ mounting plate using suitable fasteners on the ground

5.3 Connecting pipes/flexible pipes

Silencers:

The units are supplied by default with silencers for suction and discharge.

Factory-fitted blind covers must not be removed!

- **Normal pressure type**

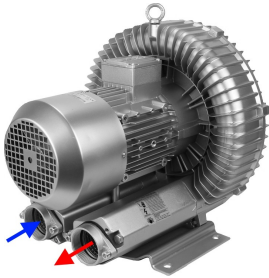

Figure 4: single stage / double flute unit (NS- / NDF-)

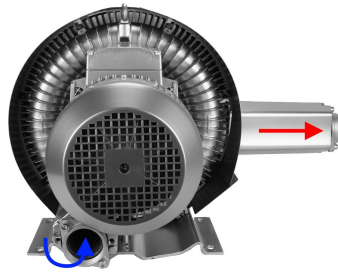

Figure 5: double stage unit (ND-)

For the **single stage** design (NS-50 up to NS-1370) and the **double flute** design (NDF-500 up to NDF-1940) these silencers are already mounted on delivery (see 4). For the **double stage** design (ND-88 up to ND-1110) the discharge-side silencer is included loose for packaging-related reasons. This has to be mounted by the operator in accordance with 5.

For the double stage design a 90° bend for the pressure-side silencer is optionally available as an accessory. Using this bend the pressure-side silencer can be aligned parallel to the suction silencer.

- **High pressure type**

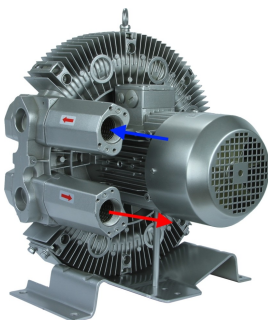

Figure 6: single stage unit (HS-)

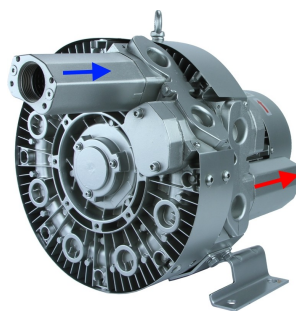

Figure 7: double and triple stage unit (HD- / HT-)

For the **single stage** design (HS-47 up to HS-165) these silencers are already mounted on delivery (see 4). For the **double and triple stage** design (HD-47 up to HD-165 / HT-120 / HT-170) the suction-side silencer is included loose for packaging-related reasons. This has to be mounted by the operator in accordance with 7.

	CAUTION
	<p>Risk of material damage due to contamination!</p> <p>→ The interior of the unit has to be free of contamination!</p> <p>→ It has to be prevented that dirt/dust can be sucked!</p> <p>If this risk exists, it is necessary to provide a suitable filter (10 microns or less).</p>

When designing the pipes/hoses the following guidelines should be observed :

- the suction (vacuum) has to be made via a vacuum-tight flexible hose or through a decoupled piping
- the pressure release (compression) have to be made via a pressure-tight flexible hose or through a decoupled piping
- when using pipes, it is to ensure that no forces are transferred to the unit and if necessary compensators have to be used



A fixed piping is not permitted!

- the flow resistance in the pipes/hoses should be kept as low as possible
- Diameter of the suction/discharge line should be at least as large as the corresponding connection diameter on the unit
- sudden changes in cross section have to be avoided
- on the suction side a filter **has to** be provided against pollution
- the exhaust air/compressed air line is either equipped with a continuous gradient, a liquid separator or a siphon with drain valve so that no condensate can flow back into the aggregate

When installing the lines ensure the following :

- Before installation all pipes and hydrants have to be cleaned
- Make sure that no gasket or sealing material (sealing tape) extends into the interior
- The flanges have to be free of flange lids, plugs and/or security films

Both the suction as well as the discharge connection with the corresponding silencer is marked by an arrow, that indicates the direction of conveyance.

Depending on the silencer design (depending on model) and the selected line type (tube/hose) suction / discharge nozzle have to be connected differently:

- Silencer with internal thread:
Screw conduit fitting (optional) into the silencer, put off hose and secure with a hose clamp
- Silencer without internal thread:
Screw hose flange (optional) or conduit fitting (optional) onto the silencer using the supplied thread flange, put off hose and secure with a hose clamp
- when **connecting to a pipe**, it is necessary to **decouple the side channel blower** by using a compensator (e.g. flexible tube)!

In addition following have to be observed in the various operating modes:

- If, in vacuum operation, the vacuum should be maintained, even after switching off the unit, a manually operated or automatic valve (check valve) in the suction line has to be provided
- Make sure that there are no foreign materials (e.g. solder) in the suction line
- If there is the risk that the aggregate – valid for vacuum and pressure operation – operates over a period of more than a few seconds against a closed inlet/outlet
→ Provide a vacuum/pressure limiting valve and set it to ~90% of the maximum differential pressure (according to nameplate)



Control of vacuum / pressure:

- In the case of vacuum operation provide venting valves for the degradation of excess vacuum or for limiting the flow of air. Do not limit the vacuum or gas flow through constriction of the suction or compression line cross-sections.
- i* By conveying bypass air the unit runs cooler and requires less power.
- In the case of pressure operation provide blow-off valves to reduce excess pressure or limiting the airflow. Do not limit the pressure or gas flow through constriction of the suction or compression line cross-sections.
- i* By blowing off excess air the unit runs cooler and requires less power.

5.4 Electrical connection

The electrical connection have to be carried out in accordance with the following guidelines:



- appropriate VDE or national regulations
- the applicable national, local and system-specific regulations
- applicable regulations of the utility company at the location of installation

	 DANGER
	<p>Electrical danger!</p> <p>Any electrical work have to be performed by a qualified electrician!</p> <p>Before starting work on the unit the following provisions have to be performed:</p> <ul style="list-style-type: none"> • Disconnect unit from the mains • Ensure the absence of voltage • Secure against restart • Earth and short circuit • Cover and safeguard neighboring live parts

The data **on the nameplate** of the motor must necessarily match with the conditions at the set-up place!

Permissible deviations (without reduction in performance):

- ± 5% voltage deviation
- ± 2% frequency deviation

 	 WARNING
	<p>Risk due to pressure and vacuum! Risk caused by escaping media!</p> <p>Before starting work on the unit:</p> <ul style="list-style-type: none"> • Unit and pipes depressurized <p>Electrical danger!</p> <p>Terminal box has to be free from:</p> <ul style="list-style-type: none"> • foreign bodies • contamination • humidity

The electrical connection has to be made in accordance with the circuit diagram in the terminal box cover, thereby the following should be noted:

- Protective earth has to be connected
- Terminals have to be used
- Ensure that the connections are safe in the long term
- Terminal box cover and cable entries have to be sealed to dust and water

 The terminal box has to be checked regularly for leaks

Wiring diagram AC motor:

- Connection with 1 capacitor (230 V):
 → See cover of the terminal box (left & center: the capacitor / right & center: the supply voltage)
- Connection with 2 capacitors (115 V / 230 V):

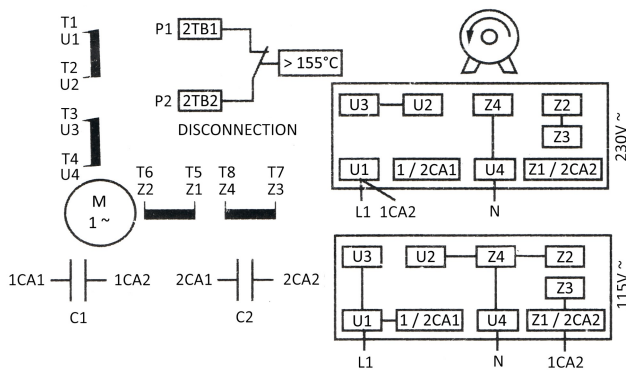

Wiring diagram three-phase motor:

- Delta connection (low voltage):

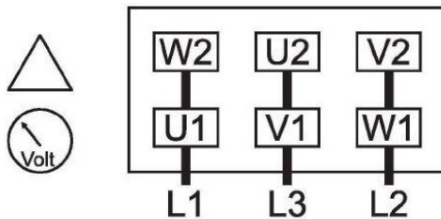

- Star connection (high voltage):

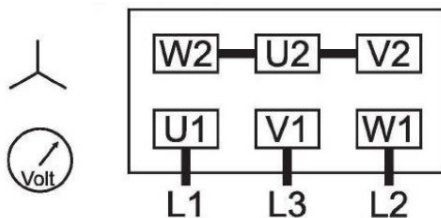

According to standard EN 60204-1 chapter 7.3 an aggregate with a rated power of more than 0.5 kW **has to** be protected against inadmissible heating. The use of a motor protection switch protects the motor against overload as well as a short circuit. This motor protection switch has to be set to the nominal current indicated on the nameplate of the motor.

	CAUTION
	<p>Risk of material damage due to incorrect direction of rotation!</p> <p>An operation in the wrong direction of rotation can damage the aggregate in a short time</p> <p>→ Before starting up the unit check for correct direction of rotation!</p> <p>→ Check polarity of the electrical connection (if necessary swap two phases)!</p>

Check for correct direction of rotation:

- Determine the intended direction of rotation by means of the glued/molded arrow
- Turn on the driving motor for a split second
- Determine the direction of rotation by means of the external fan wheel shortly before the standstill
 → If the direction of rotation is wrong swap any two phases (three-phase motor)



Operation with frequency converter (FC):



	WARNING
	<p>Units with UL approval in the United States may not be operated on frequency converters without testing by an appropriate inspection!</p>

The following have to be observed for operation with frequency converter:

- Depending on the design of the frequency converter electromagnetic emissions may occur, which arise from high-frequency current and voltage harmonics in the motor supply cables
- EMC instructions of the frequency converter manufacturer have to be observed!
- Use shielded cables and connect the shield over a large area to the metal terminal box conductively with a metal screw
- Each motor is equipped with a BMS (**BiMetalSwitch**), which can be connected to the thermistor input of the FC through two wires (in the terminal box)
- Limits of the frequency have to be maintained (see nameplate)
- The maximum inverter input voltage is 460V

6 Operation

	 WARNING
	<p>Risk due to pressure and vacuum! Risk caused by escaping media!</p> <p>Before operating the unit the following conditions have to be met:</p> <ul style="list-style-type: none"> • At the connections suction and pressure lines were installed • All lines are tight and have a sufficient strength • All lines must not be closed, blocked or dirty <p>→ When working on the unit protective equipment has to be worn!</p>
	<p>Danger from rotating parts!</p> <p>Before operating the unit the blower cover, the silencers on the suction/discharge nozzle and the fan cowl have to be installed!</p>
	<p>Risk of injury from the operation of the unit!</p> <p>When operating the unit the following has to be avoided:</p> <ul style="list-style-type: none"> • To touch the aggregate • Performing works on aggregate

	 DANGER
	<p>Electrical danger!</p> <p>Any electrical work has to be performed by a qualified electrician!</p> <p>Before starting work on the unit the following provisions have to be performed:</p> <ul style="list-style-type: none"> • Disconnect unit from the mains • Ensure the absence of voltage • Secure against restart • Earth and short circuit • Cover and safeguard neighboring live parts

6.1 Preparations prior to commissioning

- Identification of the unit model by the nameplate (see chapter 3.1, page 7)
- For treated and/or stored aggregates the seals have to be removed (see chapter 4.3, page 9)
- Determination / verification of downtime
 - for downtime **over** a year the manufacturer have to be contacted for necessary steps
 - for a downtime of less than one year the prescribed steps (see chapter 6.2, commissioning) have to be performed

6.2 Commissioning

Start up:

	CAUTION
	<p>Risk of material damage due to overload!</p> <p>→ A suction-side shut-off valve has to be fully open. Throttling on the suction side is prohibited!</p> <p>→ A pressure-side shut-off valve is to open. The unit must not be operated with closed shut-off valve!</p> <p>The operating limits (see chapter 9.1, page 22) of the unit have to be observed.</p>

The following have to be checked **before the first start-up:**

- Tightness of the piping and hose connections
- Direction of rotation
- Correct electrical connection of the motor
Set motor protection switch to the specified nominal current!
- The values given on the unit (nameplate) have to be observed!
- The unit is prepared

Then continue with the following steps:



- Open the suction-/pressure-side fitting
The unit must not be operated with closed shut-off valve!
- Turning on the engine



Shutdown:

- Shutting down the motor
- Close the suction-/pressure-side shut-off valve
- repeat checking for leaks of the lines, the unit and the fittings

Verification of operating speed:



The operating speed indicated on the nameplate of the unit has to be observed and adhered to. Exceeding the nominal speed deteriorates noise radiation, vibration behavior, service life of the bearing grease and therefore the bearing replacement intervals.



	 WARNING
	<p>Risk of serious hearing damage due to noise radiation because of missing / defective silencers!</p> <p>The actual noise emission during operation may vary from the measured noise emission values of the manufacturer, as they are highly dependent on installation and system conditions.</p> <p>Therefore carry out an acoustic emission measurement after installing the unit and if necessary following steps shall be taken:</p> <ul style="list-style-type: none"> • Noise area marked with warning sign • Wear hearing protection • When air is freely sucked or blown-off from ambient additional silencers have to be provided
	<p>Risk of hearing damage!</p> <p>Depending on the size, the side channel blower is emitting noise of high volume. Depending on the operating state the side channel blower may emit noise in a narrow frequency band.</p> <p>➔ For longer stays in the vicinity of a non noise insulated side channel blower ear protection should be worn!</p>

	 WARNING
	<p>Risk of burns by hot surfaces and/or hot media!</p> <p>In operation the unit must not be touched because it may result in temperatures above 70°C at the surface!</p> <p>The installation of the unit has to be executed in such a way (e.g. perforated plate/wire cover) that accidental contact is prevented!</p> <p>Allow to cool after decommissioning!</p>

	CAUTION
	<p>Risk of corrosion due to condensate!</p> <p>Remove closures periodically, so that accumulated water can escape.</p> <p>Risk of bearing damage!</p> <p>Mechanical shocks at standstill and in operation are to be avoided.</p>

6.3 Decommissioning

	 DANGER
	<p>Electrical danger!</p> <p>The electrical connection has to be performed by qualified electricians!</p> <p>Before starting work on the unit following actions have to be performed:</p> <ul style="list-style-type: none"> • Disconnect unit from the mains • Ensure the absence of voltage • Secure against restarting • Earth and short circuit • Cover and safeguard neighboring live parts

 	 WARNING
	<p>Risk due to pressure and vacuum! Risk caused by escaping media!</p> <p>Before starting work on the unit:</p> <ul style="list-style-type: none"> • Unit and pipes depressurized <p>→ When working on the unit protective equipment has to be worn!</p> <p>→ Escaping fluids have to be collected and disposed of in accordance with the guidelines!</p>

6.4 Recommissioning

For longer storage of more than one year, all the steps of commissioning – as described in chapter 6.1, „Preparations prior to commissioning“ and chapter 6.2, „Commissioning“ – have to be performed.

Depending on the length of storage and the storage conditions the applied sealed rolling bearings need to be replaced when recommissioning the aggregate:

- Under favorable storage conditions: 4 years
- under unfavorable storage conditions (as specified above): 2 years

Further information on storage conditions can be found in chapter 4.2.



After a long downtime the insulation resistance of the motor should also be measured and checked. The motor winding is too wet for values of less than 1 kOhm per volt of rated voltage and have to be dried.



If the unit is temporarily turned off and supposed to remain ready for operation, it is sufficient, if the unit is operated once a week.



The following provisions have to be performed if the pump / unit is taken out of operation or shut down:



- If the unit is shut down but will remain operational:
 - Once a month, put the unit briefly (5-10 minutes) into operation
- If the unit is taken out of operation:
 - Shut down unit
 - Close shut-off valves on the suction / discharge connections and relief pressure
- If the unit is dismantled:
 - Take unit from the mains and secure it against unauthorized activation
 - Dismantle pipes / hoses
 - Close all connections / fittings
- If the unit is decommissioned for an extended period or stored, the appropriate actions (see chapter 4.2, page 9) have to be performed





7 Service and maintenance

	 DANGER
	<p>Electrical danger!</p> <p>The electrical connection has to be performed by qualified electricians!</p> <p>Before starting work on the unit the following actions have to be performed:</p> <ul style="list-style-type: none"> • Disconnect unit from the mains • Ensure the absence of voltage • Secure against restarting • Earth and short circuit • Cover and safeguard neighboring live parts

 	 WARNING
	<p>Risk due to pressure and vacuum! Risk caused by escaping media!</p> <p>Before starting work on the unit:</p> <ul style="list-style-type: none"> • Unit and pipes depressurized <p>→ When working on the unit protective equipment has to be worn!</p>

	 WARNING
	<p>Danger from rotating external fan!</p> <p>The fan cover must not be dismantled!</p> <p>Danger from rotating impeller of the unit!</p> <p>Before starting work on the unit, the unit has to be taken out of service and the impeller completely stopped!</p>

	 WARNING
	<p>Danger of burns from hot surfaces and / or hot fluids!</p> <p>In operation, the unit must not be touched! Allow to cool after decommissioning!</p>

  	 CAUTION
	<p>Overturning or falling loads can lead to bruising, fractures, etc.! Cuts from sharp edges!</p>
	<p>→ While transporting and handling the unit protective equipment has to be worn!</p>

7.1 Monitoring of the aggregate

The following points have to be checked at regular intervals:

- Compliance with the maximum permissible vacuum/compression pressure and the permitted volume values
- Contamination of the motor and the filter
- Conspicuous running noise of the ball bearings
- Current consumption of the motor

For trouble-free operation pay attention to:

- Tightness of the connections and the aggregate
- Intact and clean filter
- No overload
- No unusual running noises or vibrations

7.2 Cleaning of contaminations

The unit is largely maintenance- free but – depending on the installation site – it has to be cleaned at regular intervals.

Therefore, following actions have to be performed regularly:

- To remove volatile residues purge the aggregate with air and return it to outside pressure
- Periodically remove dirt, which is in the cooling fins, the external fan and the fan cowl of the motor.
 - Clean using compressed air
- Depending on the dust at the installation site the filters are regularly
 - to clean with compressed air
 - or if necessary to replace completely

7.3 Replacing the deep groove ball bearings

The bearings used are sealed on both sides **only** with shields. Therefore they have to be changed according to this capital in the following intervals!

If the unit is operated according to its intended use (see chapter 2.1), in compliance with the operating conditions (see chapter 9.1) and according to the specific type plate, the rolling bearings have to be replaced **every 2 years**.

Generally both the motor-side and the compressor-side (impeller-side) deep groove ball bearings have to be replaced in this interval.

Instructions for disassembling and disassembling the unit can be found below in Chapter 7.6 and 7.7.

The following scenarios lead **among others** to a shortening of the change interval:

- Operation with insufficient filtering
- Overload and overheating of the unit
- Exceeding the permissible switch-on processes
- Pumping of unsuitable media
- Insufficient decoupling (low vibration) of the unit
- Inadmissible operating conditions

7.4 Service / Support

For maintenance and repair work, please contact our service.

When returning the unit the following have to be observed:

- Unit has to be cleaned inside and outside (see chapter 7.2, page 17)
- Unit must not be disassembled and has to be supplied with all the necessary parts
- The identification of the unit on the nameplate has to be readable
- Any returning aggregate has to be accompanied by a duly completed "Declaration of Harmlessness"
- For returning the original packaging should be used

7.5 Spare parts



As spare parts, only the rolling bearings and seals are provided (see 10, page 25). If other parts are necessary for the maintenance, contact your responsible representative of the SKV-tec GmbH to determine, whether a repair is economically or whether a replacement should be considered.



When ordering spare parts and accessories the following information is required:

- Complete model code of the unit using the nameplate (see chapter 3.1, page 7)
- Serial number (S/N) of the aggregate (see chapter 3.1, page 7)
- Position and parts designation

Commercially available standard parts can be purchased in free trade.

7.6 Disassembly of the unit

 DANGER	
	Electrical danger!
	<p>The electrical connection has to be performed by qualified electricians!</p> <p>Before starting work on the unit the following actions have to be performed:</p> <ul style="list-style-type: none"> • Disconnect unit from the mains • Ensure the absence of voltage • Secure against restarting • Earth and short circuit • Cover and safeguard neighboring live parts

 WARNING	
 	Risk of injuries when the engine is running!
	<p>During operation the unit must not be touched! During operation, no work may be performed on the unit!</p> <p>Risk due to pressure and vacuum! Risk caused by escaping media!</p> <p>Before starting work on the unit, the unit and the lines have to be depressurized</p>

Before disassembly work on the unit the following conditions have to be met:

- The safety instructions have to be observed
- The unit is shut down and disconnected from the mains
- Connected pipes / hoses and equipment such as separators, pressure gauge, etc. are disassembled
- The unit has been removed from the system and is on a clean, flat assembly area

Disassembling the impeller-side rolling bearing:

- (1) Disassembling blower cover
 - Put the aggregate on the fan bowl
 - Loosen and remove the screws of the blower cover
 - Loosen and remove the screws of the bearing cover
 - Removal of the blower cover

The plane surfaces of the blower cover/housing must not be damaged!
- (2) Disassembling bearing cover
 - Loosen and remove the screw and washer of the shaft lock
 - Pull the bearing cover including bearing using a suitable detaching device from the motor shaft
 - Press bearing out of the bearing cover

Disassembling the motor-side rolling bearing:

- Set up unit horizontally
- Remove the fan cowl
- Loosen and pull off the external fan from the motor shaft, if necessary remove retaining ring
- Loosen the screws of the end shield and remove the end shield
- Pulling off the rolling bearing of the motor shaft

7.7 Assembling of the unit

	CAUTION
	<p>Risk of material damage due to improper assembly!</p> <ul style="list-style-type: none"> ➔ Assemble the unit according to the guidelines for engineering! ➔ Use only original parts! ➔ Carry out the assembly on a clean, level assembly area!

Furthermore, please note the following:

- Worn parts have to be replaced by original Spare Parts
- Use only functional and tested parts
- Seals generally have to be replaced
- All parts have to be cleaned
- The necessary tightening torques are to be observed



Assembling the impeller-side rolling bearing:



- (1) Assembling of the bearing cover
 - Put the aggregate on the fan cowl
 - Press bearing into the bearing cover
 - Press the bearing cover including bearing using a suitable attaching device on the motor shaft
 - Reattach the screw and washer of the shaft lock
- (2) Assembling of the blower cover
 - Align the blower cover on the blower housing, paying attention to the orientation of the bearing cover
 - Tightly coil the bearing cover on the blower cover
 - Tightly coil the blower cover on the blower housing

Assembling the motor-side bearing

- Set up unit horizontally
- Pressing the rolling bearing on the motor shaft
- Align the end shield and screw it to the motor housing
- Press the external fan on the motor shaft
- Reassembly of the fan cowl

8 Troubleshooting

	 DANGER
	<p>Electrical danger!</p> <p>The electrical connection has to be performed by qualified electricians!</p> <p>Before starting work on the unit the following actions have to be performed:</p> <ul style="list-style-type: none"> • Disconnect unit from the mains • Ensure the absence of voltage • Secure against restarting • Earth and short circuit • Cover and safeguard neighboring live parts

 	 WARNING
	<p>Risk of injuries when the engine is running!</p> <p>During operation the unit must not be touched! During operation, no work may be performed on the unit!</p> <p>Risk due to pressure and vacuum! Risk caused by escaping media!</p> <p>Before starting work on the unit, the unit and the lines have to be depressurized</p>

If the operator of the unit can not resolve the disturbance, the contact person responsible for the maintenance of the unit is to be contacted.

If the problem can not be resolved, contact your responsible representation of the SKV-tec GmbH!

Defect	Cause	Rectification
Engine will not start (no running noise)	At least two phases of the power supply are interrupted	Check the power supply and eliminate interruption
	One phase of the power supply is interrupted	Check the power supply and eliminate interruption
	Motor protection switch has triggered	Check the motor and switch on protection switch again
	Motor blocked	Check the motor
Engine does not start (humming noise)	Impeller is stuck	Open blower cover, remove foreign material and clean side channel (see chapter 7.2, page 17) If necessary check or correct impeller gap
	Contamination of the pump	Clean the aggregate (see chapter 7.2, page 17)
	defective impeller	Replace impeller (service)
	Defective motor bearings	Replace motor bearings
Motor protection switch triggers	Short circuit in the motor winding	Check the motor winding
	Incorrect setting of the motor protection switch	Check settings, if necessary, replace the motor protection switch
	Excessive back pressure in the pressure side connection	Reduce back pressure if necessary clean filters and periphery
	Blocked / Plugged suction side	Open / freely accessible suction side
	Motor / pump blocked	See "Engine does not start"

Defect	Cause	Rectification
Excessive power consumption of the engine	Excessive back pressure in the pressure side connection	Reduce back pressure if necessary clean filters and periphery
	Blocked / Plugged suction side	Open / freely accessible suction side
	Contamination of the pump	Clean the aggregate (see chapter 7.2, page 17)
	Too high viscosity of the conveying media	Use a recommended conveying media
No vacuum or insufficient vacuum generation by the pump	Leak in the system	Check system for leaking spots
	Leakage on suction side	Check the suction side connections / pipes
	Wrong direction of rotation of the motor	Check direction of rotation (see chapter 5.4, page 12)
	Incorrect frequency (when using a frequency converter)	Correct switching frequency
	Spindle speed too low	Increasing the speed (consulting producer)
	Density of the pumped medium too high	Pressure values have to be converted (consulting producer)
	Wear / defect of the shaft seal	Replacing the shaft seal (Service)
	Wear / changes of the impeller profile	Clean impeller if necessary replace it(Service)
	Unit undersized	Exchange / Replace with larger unit
Unusual noises	Too high flow velocity	Clean lines or use larger line cross-section
	Blocked / Plugged suction side	Open / freely accessible suction side, if necessary install a safety valve
	Spindle speed too high	Decreasing the speed (consulting producer)
Aggregate leaking	Defective silencer seal	Check/Replace silencer seal
	Defective motor seal	Replace corresponding seal (service)
	Wear on housing parts	Replacement of the affected parts
	Loose fittings / connections	Sealing the connections, if necessary, replace the seals
Poor Running of the aggregate	Defective pump / motor bearing	Replacement of the affected bearings
	Vibrational resonances in the pipe system	Inspection of the line system if necessary use of dampeners / mountings
	Imbalance in the impeller	Replace impeller (service)
	Deposits on the impeller	Clean/Replace impeller (service)

9 Technical Specifications

The model-specific technical data are referred to the separate data sheets of the model series.

9.1 Operating conditions

Temperatures:

- Temperature of the transported gas
 - max. permissible temperature: +40°C
 - Nominal value of the temperature: +15°C
- Temperature of the ambient
 - max. permissible temperature: +40°C
 - min. permissible temperature: -15°C
 - Nominal value of the temperature: +25°C

i Deviating temperatures from the nominal value have an impact on the permissible pressure differences. At higher temperatures, both damage to the motor windings as well as a shortening grease durability of the bearings can not be excluded.

Pressures:

- max. suction-side pressure differential (vacuum): **see nameplate**
- max. pressure-side pressure difference (pressure): **see nameplate**

i The pressure differences indicated (on the nameplate) are exclusively under the following conditions:

- Ambient temperature: **+25°C**
- Ambient pressure in vacuum/pressure operation: **1013 mbar** at suction / discharge nozzle
- Intake temperature of the transported gas: **+15°C**

In **continuous operation** the side channel blowers may only be loaded with 90% of the maximum pressure difference (see nameplate, applies both to the maximum vacuum and pressure difference). If the ambient temperature is at 25 – 40°C these pressure differences additionally have to be reduced linearly to the temperature by 0 – 10%.

Altitude is max. 1000 m above sea level.

For divergent operating conditions consultation with your responsible representation of the SKV-tec GmbH is required!

9.2 General technical data

Minimum distance WT (heat dissipation):

Minimum distance of the fan cowl to adjacent surfaces:

Model type	[mm]
SKV-NS-50 up to SKV-NS-180 SKV-ND-88 up to SKV-ND-150 SKV-HS-47 up to SKV-HS-66 SKV-HD-47 up to SKV-HD-65	34
SKV-NS-210 up to SKV-NS-1370 SKV-ND-230 up to SKV-ND-1110 SKV-NDF-500 up to SKV-NDF-2050 SKV-HS-87 up to SKV-HS-165 SKV-HD-87 up to SKV-HD-165 SKV-HT-120 up to SKV-HT-170	53

Minimum distance of the clearance surfaces of the blower cover to adjacent surfaces:

Model type	[mm]
SKV-NS-50 up to SKV-NS-180 SKV-ND-88 up to SKV-ND-150	15
SKV-NS-210 up to SKV-NS-280 SKV-ND-230	20
SKV-NS-318, SKV-ND-320 and SKV-NDF-500 SKV-HS-47 up to SKV-HS-165 SKV-HD-47 up to SKV-HD-165 SKV-HT-120 up to SKV-HT-170	30
SKV-NS-530 up to SKV-NS-1370 SKV-ND-520 up to SKV-ND-1110 SKV-NDF-900 up to SKV-NDF-2050	40

10 Indications according to ecodesign regulation (EU) 2019/1781

Exemption from requirements according to EU 2019/1781 Art.2, Sec. 2a)

11 Appendix

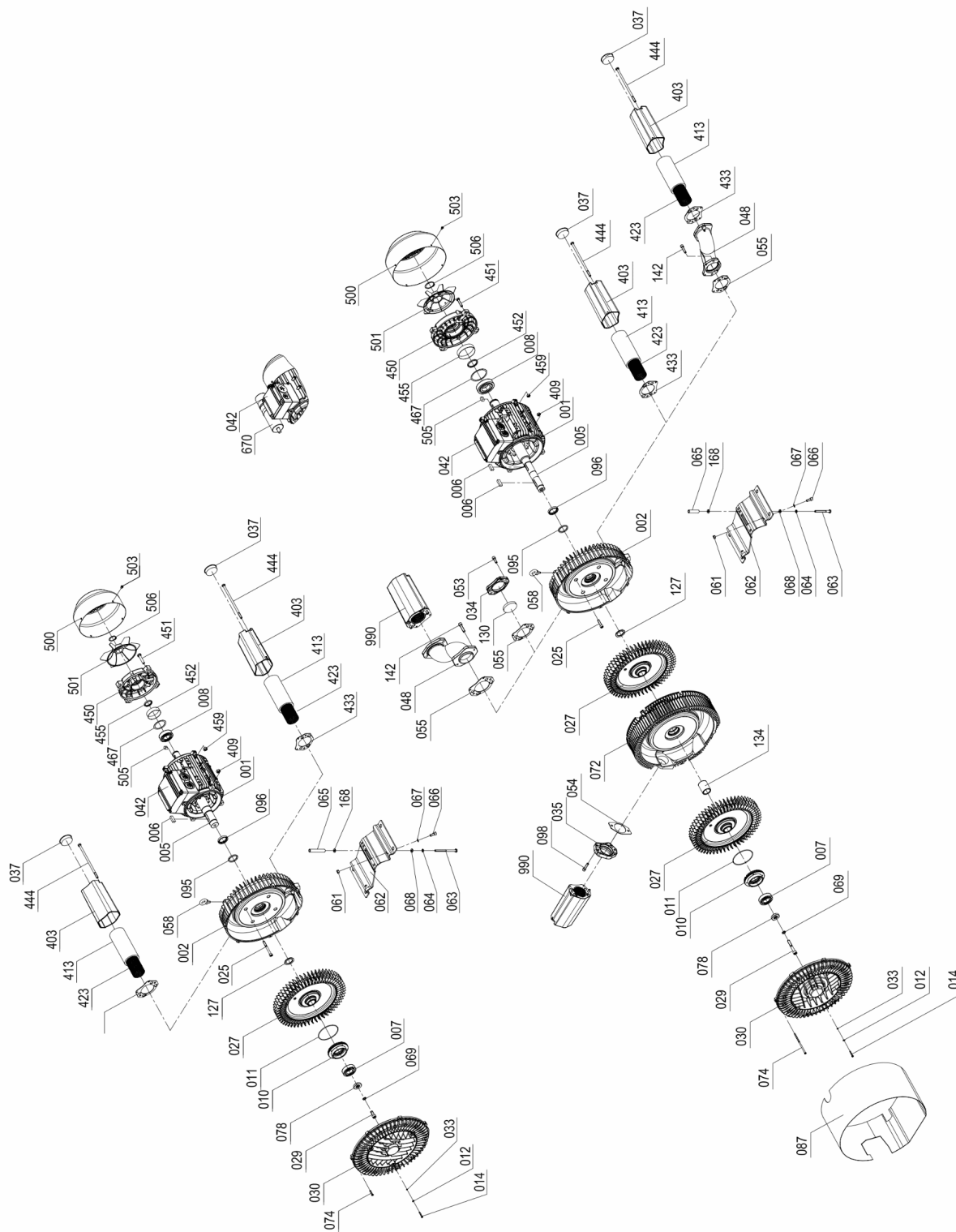

Figure 8: Exploded Drawing of the series -NS / -ND / -NDF

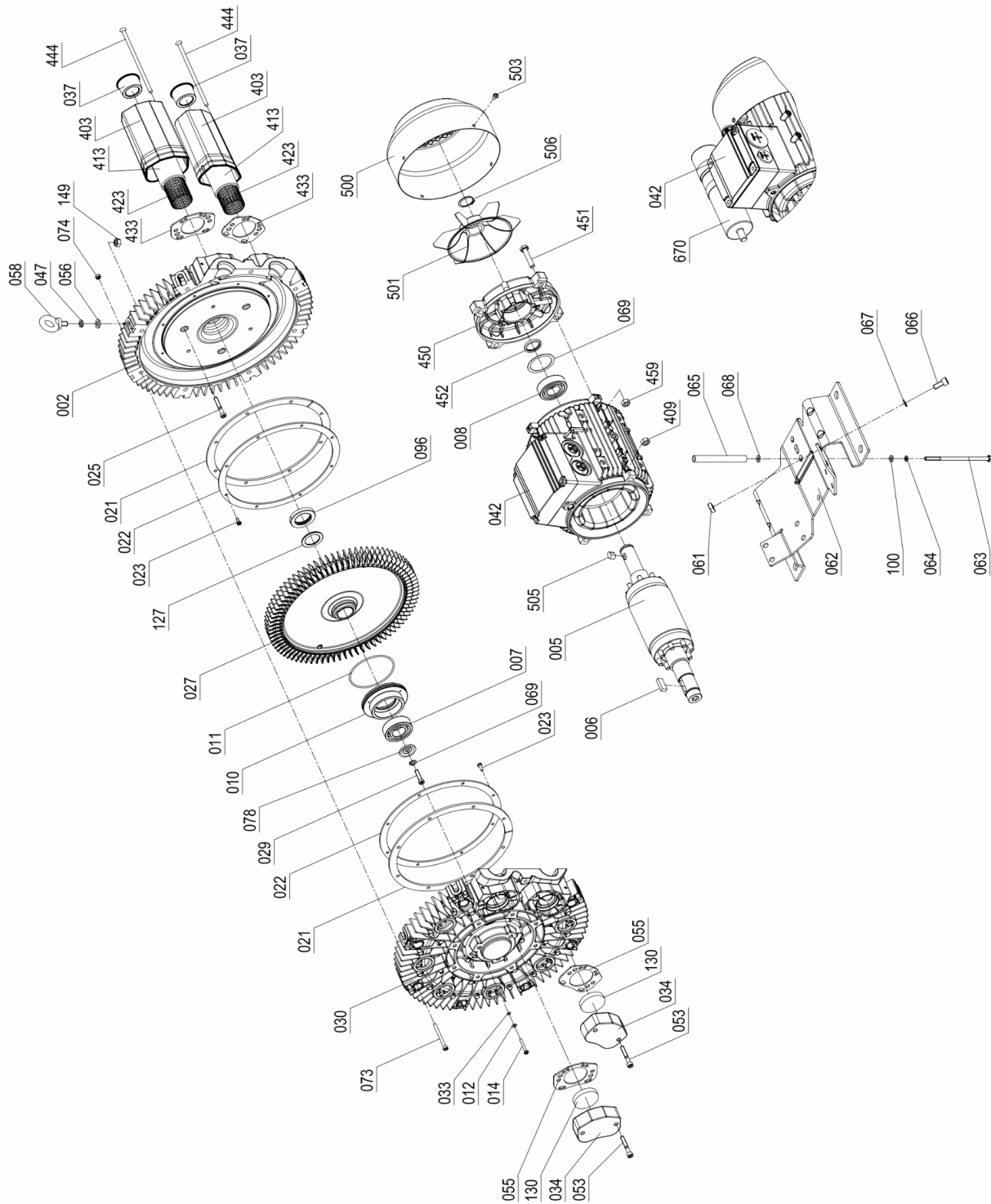

Figure 9: Exploded Drawing of the -HS series

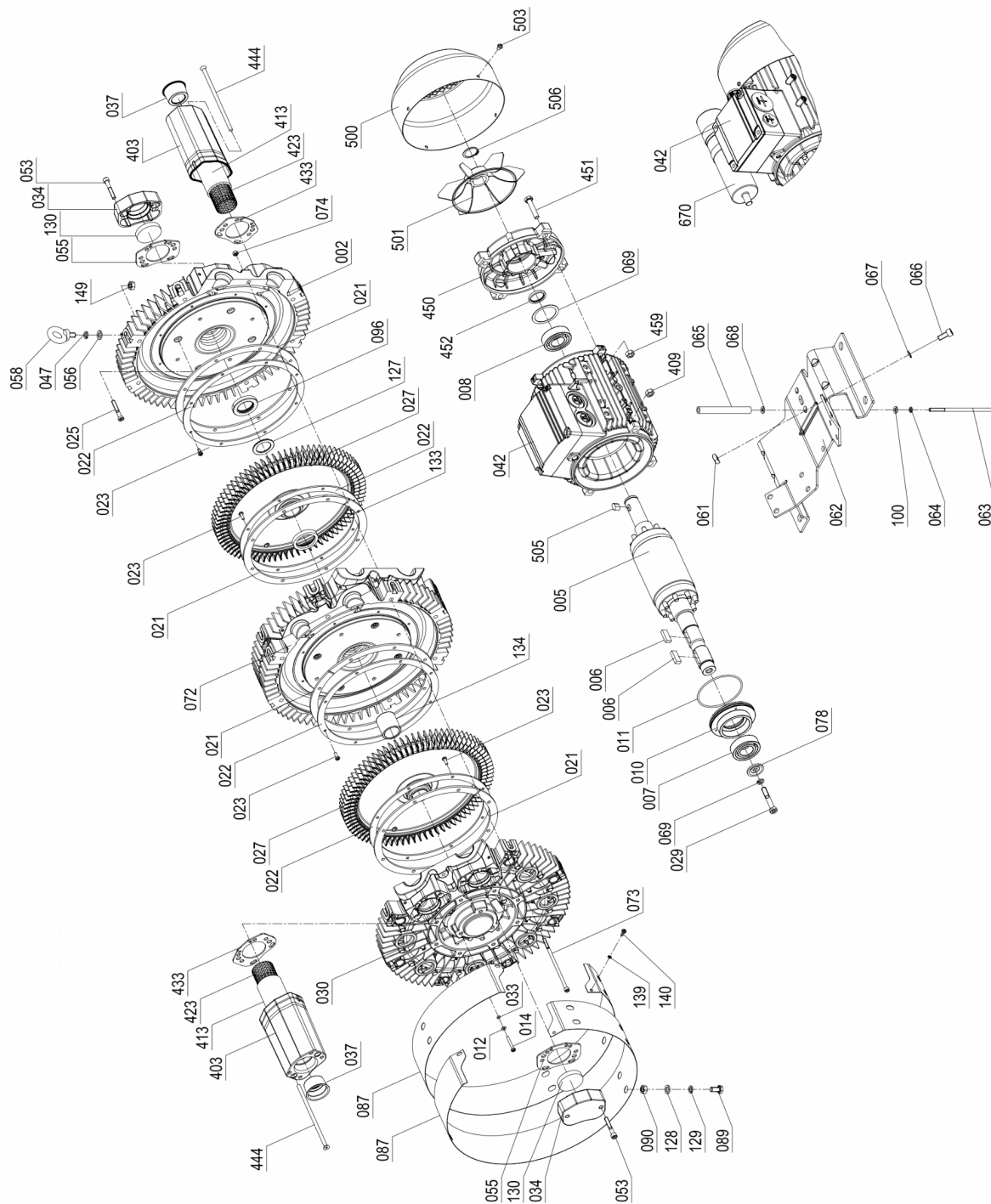

Figure 10: Exploded Drawing of the series -HD

Teilenr. / No	Bezeichnung des Teils	Description
001	Motorgehäuse komplett	Motor housing complete
002	Verdichtergehäuse	Blower housing
005	Motorläufer	Motor rotor
006	Passfeder	Parallel key
007	Rillenkugellager (laufradseitig)	Deep groove ball bearing (impeller side)
008	Rillenkugellager (motorseitig)	Deep groove ball bearing (motor side)
010	Lagerdeckel komplett	Bearing cover complete
011	O-Ring (laufradseitig)	O-ring (impeller side)
012	Scheibe	Washer
021	Teflon-Dichtung	Teflon seal
022	Sicherungsring	Retaining ring
027	Laufrad	Impeller
030	Verdichterdeckel	Blower cover
034	Flansch	Flange
035	Flansch	Flange
037	Verschlusskappe	Cap
042	Klemmenkasten komplett	Terminal box complete
048	S-Rohr	S-pipe
054	Dichtung	Gasket
055	Dichtung	Gasket
062	Fuss (Grundplatte)	Base
072	Mittelkörper	Centre section
078	Scheibe	Washer
087	Verdichterhaube	Blower cowl
095	Filzring	Felt ring
096	Radial-Wellendichtring	Rotary shaft lip type seal
130	Füllstück	Filler
134	Hülse	Sleeve
403	Schalldämpfergehäuse	Silencer housing
413	Schalldämpfereinsatz	Silencer inlet
423	Gitterrohr	Net pipe
433	Dichtung	Gasket
450	Lagerschild	End shield
452	Radial-Wellendichtring	Rotary shaft lip type seal
467	Federscheibe	Spring lock washer
500	Lüfterhaube	Fan cowl
501	Außenlüfter	External fan
505	Passfeder	Parallel key
506	Sicherungsring	Retaining ring
670	Kondensator	Capacitor
990	Schalldämpfer komplett	Silencer complete

Table 2: Spare Part List

EC – Declaration of Conformity

Object of the declaration: Side Channel vacuum pump / compressor
of the SKV-NS/-ND/-NDF/-HS/-HD/-HT-Series

Types: **SKV-NS-.... / SKV-ND-.... / SKV-NDF-....**
SKV-HS-.... / SKV-HD-.... / SKV-HT-....

We hereby declare that the pump units described above – in its delivered state – complies with the following relevant provisions:

2006/42/EC,
ABI. L 157 of 9.6.2006

Directive 2006/42/EC of the European Parliament and of the Council of 17.5.2006 on machinery and amending Directive 95/16/EC

2011/65/EU,
ABI. L 174 of 1.7.2011

Directive 2011/65/EU of the European Parliament and of the Council of 8.6.2011 on the restriction of the use of certain hazardous substances in electrical and electronic equipment

2014/30/EU,
ABI. L 96 of 29.3.2014

Directive 2014/30/EU of the European Parliament and of the Council of 26.2.2014 on the harmonization of the laws of the Member States relating to electromagnetic compatibility (only with integrated frequency inverter VACON0100 or INVEOR M)

2014/35/EU,
ABI. L 96 of 29.3.2014,
p. 357–374

Directive 2014/35/EU of the European Parliament and of the Council of 26.2.2014 on the harmonization of the laws of Member States relating to the making available on the market of electrical equipment designed for use within certain voltage limits

Applied harmonized standards:

DIN EN 1012-1:2011-02

Compressors and vacuum pumps – Safety requirements – Part 1: Air compressors

DIN EN 1012-2:2011-12

Compressors and vacuum pumps – Safety requirements – Part 2: Vacuum Pumps

DIN EN ISO 12100:2011-03

Safety of machinery – General principles for design – Risk assessment and risk reduction

DIN EN 60204-1:2019-06

Safety of machinery – Electrical equipment of machines – Part 1: General requirements

DIN EN 60034-1:2011-02

Rotating electrical machines - Part 1: Rating and performance (IEC 60034-1:2010, modified)

This declaration loses its validity if the pump assemblies described above are technically modified without our approval.

Igensdorf, 20.07.2021
(place, date)

Robert Krämer, CEO
(name and function)



(signature Robert Krämer)

SKV-tec GmbH
Forchheimer Str. 4 / D-91338 Igensdorf
Tel.: +49 (0) 9192 – 99 53 14 / Fax: +49 (0) 9192 – 99 52 68

Declaration of Harmlessness

Each returned aggregate **has to** be accompanied by a completely filled declaration!

The following criteria must comply with the declaration:

- It has to be completely filled, otherwise the repair / disposal can be refused.
- It has to be completed, checked and signed by an authorized service personnel.
- It has to be completed in German or English
- It has to be attached easily visible on the outside of of the packaging material and if necessary inform the relevant forwarding agency

Type designation: _____

Serial number (S/N): _____

Reason for return: _____

The unit came into contact with hazardous substances: yes no
(In repair / disposal danger for people and the environment)

If the unit came in contact with hazardous substances, the relevant substances are mentioned in the following:

Trade name	Chemical designation	Hazardous Material Class	Properties (e.g. corrosive, flammable, toxic)

The unit has been completely drained, flushed and cleaned both from the inside and from the outside in accordance with these operating instructions yes

All safety data sheets are enclosed yes

When handling with the aggregate, do safety precautions have to be taken? yes no

If yes, _____

Legally binding statement

We assure that all information provided are complete and correct and I - the undersigned – am authorized and empowered to confirm this. We are aware that in case of incomplete, incorrect information we are liable for damages incurred by the contractor. Due to incomplete, incorrect information we keep the contractor free from damage claims of third parties. Independent of this statement, we are aware that we are directly liable to third parties, which particularly refers to the responsible personnel for the repair of the contractor.

Company: _____ Name: _____

Street: _____ Date, signature: _____

City: _____ Stamp: _____